

<p>Number</p> <p style="text-align: center;">V7305</p>	<p>Series</p> <p style="text-align: center;">V7300 Series Trench Drain Grate Heavy Duty</p>
--	---

V7305 Trench Grate

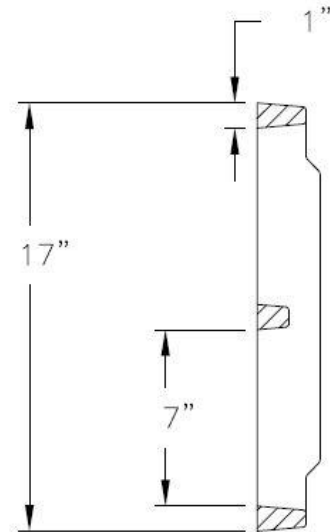

GRATE SECTION

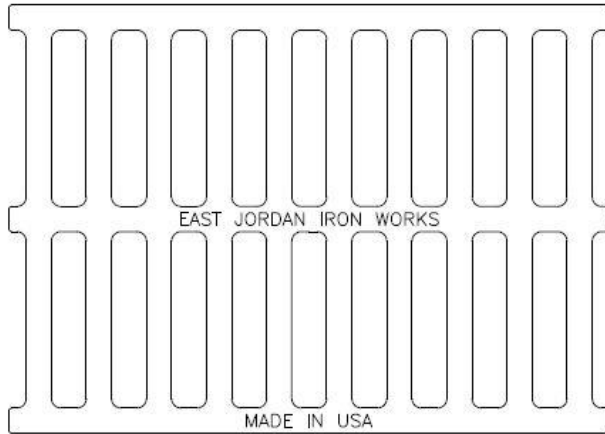
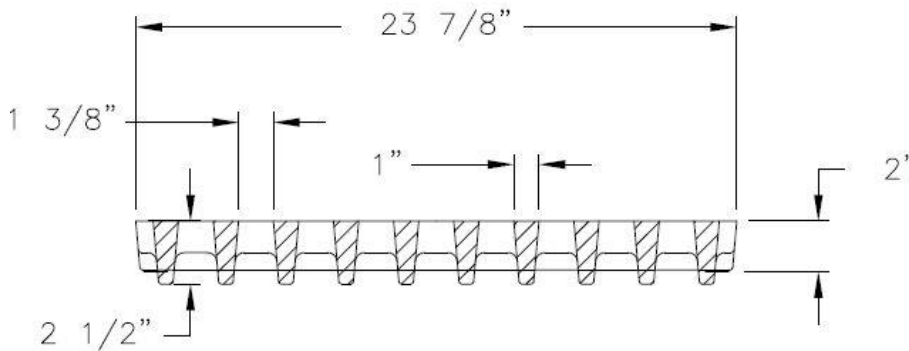

GRATE SECTION

Specification

Grate Material : Gray Iron (CL35)
Design Load: Heavy Duty
Coating: Undipped
Open Area: 199 SQ IN
Certification: ASTM A48
Country of Origin: USA

Manufacturer



DISCLAIMER - The customer and the customer's architects, engineers, consultants, and other professionals are completely responsible for the selection installation and maintenance of any product purchased from Trench Drain Supply and/or its manufacturers. TRENCH DRAIN SUPPLY MAKES NO WARRANTY, EXPRESS OR IMPLIED, AS TO THE SUITABILITY, DESIGN, MERCHANTABILITY, OR FITNESS OF THE PRODUCT FOR CUSTOMERS APPLICATION. The drawing and information provided remain the property and copyright of the manufacturer listed. The manufacturer reserves the right to modify specification without notice.